

# JVC

## SERVICE MANUAL

COMPACT COMPONENT SYSTEM

**NX-PN7J,NX-PN7C,NX-PN7B,NX-PN7E,  
NX-PN7EN,NX-PN7EV,NX-PN7A,  
NX-PN7US,NX-PN7UW,NX-PN7UJ**

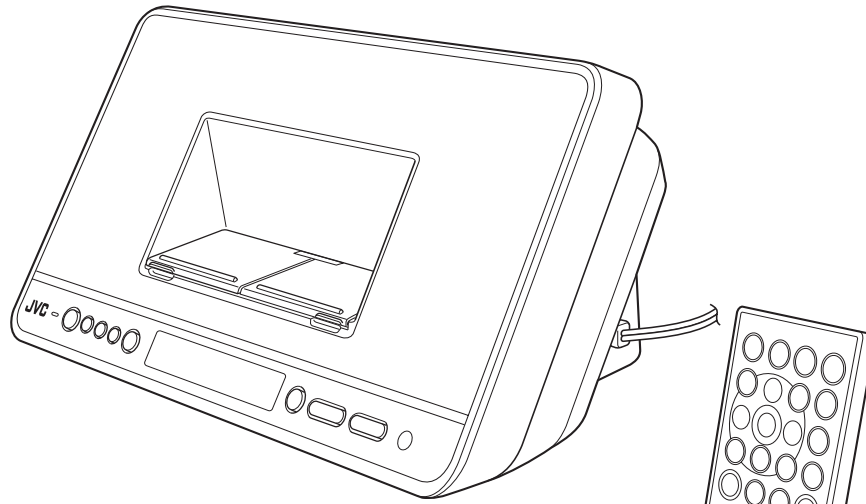

**Radio Data System**

NX-PN7B, NX-PN7E  
NX-PN7EN, NX-PN7EV

Lead free solder used in the board (material : Sn-Ag-Cu, melting point : 219 Centigrade)

### TABLE OF CONTENTS

1	PRECAUTION.....	1-5
2	SPECIFIC SERVICE INSTRUCTIONS.....	1-7
3	DISASSEMBLY .....	1-7
4	ADJUSTMENT .....	1-10
5	TROUBLESHOOTING .....	1-10



# REVISION INFORMATION

## COMPACT COMPONENT SYSTEM

**NX-PN7J, NX-PN7C, NX-PN7B, NX-PN7E,  
NX-PN7EN, NX-PN7EV, NX-PN7A, NX-PN7US,  
NX-PN7UW, NX-PN7UJ**

### ■ OVERVIEW

Add NX-PN7B, NX-PN7E, NX-PN7EN, NX-PN7EV, NX-PN7A, NX-PN7US, NX-PN7UW and NX-PN7UJ

### ■ DETAILS

#### COVER SECTION

Title	Line	No.MB675<Rev.001>	No.MB675<Rev.002>	Description
Revision		Rev.001	Rev.002	
Issue Date		2008/07	2008/09	
Model No.		NX-PN7C, NX-PN7J	NX-PN7A, NX-PN7B, NX-PN7C, NX-PN7E, NX-PN7EN, NX-PN7EV, NX-PN7J, NX-PN7UJ, NX-PN7US, NX-PN7UW	
Cover Illustration		ILLUSTRATION(mb675_0001.png)	ILLUSTRATION(mb675_0001.png)	
Category		Audio/Video Systems <b>category</b>	Audio/Video Systems <b>Division</b>	
SPECIFICATION	1		NX-PN7J,C	
	10	Dock A and B for iPod * Only for still picture. Compatible iPod types iPod nano 1GB/2GB/4GB <b>yes</b> <b>no</b>	Dock A and B for iPod * Only for still picture. Compatible iPod types iPod nano 1GB/2GB/4GB <b>Audio</b> <b>yes</b>	

Title	Line	No.MB675<Rev.001>	No.MB675<Rev.002>	Description
	11	iPod nano (2nd Generation) 2GB/4GB/8GB yes no	Video no	
	12	iPod nano (3rd Generation) 4GB/8GB yes yes	iPod nano (2nd Generation) 2GB/4GB/8GB Audio yes	
	13	iPod mini 4GB yes no	Video no	
	14	iPod mini (2nd Generation) 4GB/ 6GB yes no	iPod nano (3rd Generation) 4GB/8GB Audio yes	
	15	iPod (4th Generation) 20GB/40GB yes no	Video yes	
	16	iPod photo (4th Generation) 20GB/30GB/40GB/60GB yes yes*	iPod mini 4GB Audio yes	
	17	iPod video (5th Generation) 30GB/60GB/80GB yes yes	Video no	
	18	iPod classic 80GB/160GB yes yes	iPod mini (2nd Generation) 4GB/ 6GB Audio yes	
	19	iPod touch 8GB/16GB/32GB yes yes	Video no	
	20	iPhone 4GB/8GB/16GB yes yes	iPod (4th Generation) 20GB/40GB Audio yes	
	21	-	Video no	
	22	-	iPod photo (4th Generation) 20GB/30GB/40GB/60GB  Audio yes	
	23	-	Video yes*	
	24	-	iPod video (5th Generation) 30GB/60GB/80GB  Audio yes	
	25	-	Video yes	
	26	-	iPod classic 80GB/160GB  Audio yes	

Title	Line	No.MB675<Rev.001>	No.MB675<Rev.002>	Description
	27	-	Video yes	
	28	-	iPod touch 8GB/16GB/32GB Audio yes	
	29	-	Video yes	
	30	-	iPhone 4GB/8GB/16GB Audio yes	
	31	-	Video yes	
	54	-	NX-PN7BEENEV	
	55	-	Amplifier	
	56	-	Output Power 10 W (5 W + 5 W) at 8 $\Omega$ (10% THD) (IEC268-3)	
	57	-	Terminals	
	58	-	AUDIO IN Input Sensitivity/ Impedance (1 kHz) LEVEL 1: 500 mV/47 k $\Omega$	
	59	-	LEVEL 2: 250 mV/47 k $\Omega$	
	60	-	LEVEL 3: 125 mV/47 k $\Omega$	
	61	-	Dock A and B for iPod * Only for still picture. Compatible iPod types iPod nano 1GB/2GB/4GB Audio yes	
	62	-	Video no	
	63	-	iPod nano (2nd Generation) 2GB/4GB/8GB Audio yes	
	64	-	Video no	
	65	-	iPod nano (3rd Generation) 4GB/8GB Audio yes	
	66	-	Video yes	
	67	-	iPod mini 4GB Audio yes	
	68	-	Video no	
	69	-	iPod mini (2nd Generation) 4GB/ 6GB Audio yes	

Title	Line	No.MB675<Rev.001>	No.MB675<Rev.002>	Description
	70	-	Video no	
	71	-	iPod (4th Generation) 20GB/40GB Audio yes	
	72	-	Video no	
	73	-	iPod photo (4th Generation) 20GB/30GB/40GB/60GB Audio yes	
	74	-	Video yes*	
	75	-	iPod video (5th Generation) 30GB/60GB/80GB Audio yes	
	76	-	Video yes	
	77	-	iPod classic 80GB/160GB Audio yes	
	78	-	Video yes	
	79	-	iPod touch 8GB/16GB/32GB Audio yes	
	80	-	Video yes	
	81	-	iPhone 4GB/8GB/16GB Audio yes	
	82	-	Video yes	
	83	-	Output power (each iPod) DC 5 V 500 mA	
	84	-	VIDEO OUT (For iPod) Composite	
	85	-	PHONES  32Ω 1 kΩ	
	86	-	15 mW/ch output into 32 Ω	
	87	-	Tuner	
	88	-	FM tuning range 87.50 MHz - 108.00 MHz	
	89	-	Unit	
	90	-	Dimensions (W/H/D) 318 mm x 148 mm x 154 mm	
	91	-	Mass Approx. 1.6 kg	
	92	-	Speaker Specifications	

Title	Line	No.MB675<Rev.001>	No.MB675<Rev.002>	Description
	93	-	Type Full range bass-reflex type	
	94	-	Speakers 7 cm cone x 2	
	95	-	Impedance 8 Ω	
	96	-	Power Specifications	
	97	-	Power Source DC 10.7 V 3 A (EXTERNAL DC IN)	
	98	-	AC Adaptor (AA-R1001)  INPUT AC 110 - 240 V 50 Hz/60 Hz 1 A	
	99	-	OUTPUT DC 10.7 V 3 A 32.1 VA	
	100	-	Power Consumption  35 W (power on mode)	
	101	-	4 W or less (in Standby mode)	
	102	-	1 W or less (in ECO mode)	
	103	-	19 W (in Standby mode with two iPod devices connected.)	
	105	-	Design and specifications are subject to change without notice.	
	106	-	NX-PN7AUSUJUW	
	107	-	Amplifier	
	108	-	Output Power 10 W (5 W + 5 W) at 8Ω(10% THD) (IEC268-3)	
	109	-	Terminals	
	110	-	AUDIO IN Input Sensitivity/ Impedance (1 kHz) LEVEL 1: 500 mV/47 kΩ	
	111	-	LEVEL 2: 250 mV/47 kΩ	
	112	-	LEVEL 3: 125 mV/47 kΩ	
	113	-	Dock A and B for iPod * Only for still picture. Compatible iPod types iPod nano 1GB/2GB/4GB Audio yes	
	114	-	Video no	
	115	-	iPod nano (2nd Generation) 2GB/4GB/8GB Audio yes	
	116	-	Video no	

Title	Line	No.MB675<Rev.001>	No.MB675<Rev.002>	Description
	117	-	iPod nano (3rd Generation) 4GB/8GB Audio yes	
	118	-	Video yes	
	119	-	iPod mini 4GB Audio yes	
	120	-	Video no	
	121	-	iPod mini (2nd Generation) 4GB/ 6GB Audio yes	
	122	-	Video no	
	123	-	iPod (4th Generation) 20GB/40GB Audio yes	
	124	-	Video no	
	125	-	iPod photo (4th Generation) 20GB/30GB/40GB/60GB Audio yes	
	126	-	Video yes*	
	127	-	iPod video (5th Generation) 30GB/60GB/80GB Audio yes	
	128	-	Video yes	
	129	-	iPod classic 80GB/160GB Audio yes	
	130	-	Video yes	
	131	-	iPod touch 8GB/16GB/32GB Audio yes	
	132	-	Video yes	
	133	-	iPhone 4GB/8GB/16GB Audio yes	
	134	-	Video yes	
	135	-	Output power (each iPod) DC 5 V 500 mA	
	136	-	VIDEO OUT (For iPod) Composite	

Title	Line	No.MB675<Rev.001>	No.MB675<Rev.002>	Description
	137	-	PHONES 32Ω 1 kΩ	
	138	-	15 mW/ch output into 32 Ω	
	139	-	Tuner	
	140	-	FM tuning range 87.50 MHz-108.00 MHz	
	141	-	Unit	
	142	-	Dimensions (W/H/D) 318 mm x 148 mm x 154 mm	
	143	-	Mass Approx. 1.6 kg	
	144	-	Speaker Specifications	
	145	-	Type Full range bass-reflex type	
	146	-	Speakers 7 cm cone x 2	
	147	-	Impedance 8 Ω	
	148	-	Power Specifications	
	149	-	Power Source DC 10.7 V 3 A (EXTERNAL DC IN)	
	150	-	AC Adaptor (AA-R1001) INPUT AC 110 - 240 V , 50 Hz/60 Hz 1 A	
	151	-	OUTPUT DC 10.7 V 3 A	
	152	-	Power Consumption: 35 W (power on mode)	
	153	-	4 W or less (in Standby mode)	
	154	-	1 W or less (in ECO mode)	
	155	-	19 W (in Standby mode with two iPod devices connected.)	
	157	-	Design and specifications are subject to change without notice.	

## SECTION 1 PRECAUTION

Title	Line	No.MB675<Rev.001>	No.MB675<Rev.002>	Description
1.1 Safety Precautions	8	ILLUSTRATION(LXM-SA007-001_01.png)	ILLUSTRATION(LXM-SA009-001_01.png)	
1.5 Safety Precautions (U.K only)	T	-	1.5 Safety Precautions (U.K only)	
	1	-	1. This design of this product contains special hardware and many circuits and components specially for safety purposes. For continued protection, no changes should be made to the original design unless authorized in writing by the manufacturer. Replacement parts must be identical to those used in the original circuits.	



Title	Line	No.MB675<Rev.001>	No.MB675<Rev.002>	Description
	2	-	2. Any unauthorised design alterations or additions will void the manufacturer's guarantee; furthermore the manufacturer cannot accept responsibility for personal injury or property damage resulting therefrom.	
	3	-	3. Essential safety critical components are identified by ( ILLUSTRATION(kigo001.png) ) on the Parts List and by shading on the schematics, and must never be replaced by parts other than those listed in the manual. Please note however that many electrical and mechanical parts in the product have special safety related characteristics. These characteristics are often not evident from visual inspection. Parts other than specified by the manufacturer may not have the same safety characteristics as the recommended replacement parts shown in the Parts List of the Service Manual and may create shock, fire, or other hazards.	
	4	-	4. The leads in the products are routed and dressed with ties, clamps, tubings, barriers and the like to be separated from live parts, high temperature parts, moving parts and/or sharp edges for the prevention of electric shock and fire hazard. When service is required, the original lead routing and dress should be observed, and it should be confirmed that they have been returned to normal, after re-assembling.	
1.5.1 Warning	T	-	1.5.1 Warning	
	1	-	1. Service should be performed by qualified personnel only.	
	2	-	2. This equipment has been designed and manufactured to meet international safety standards.	
	3	-	3. It is the legal responsibility of the repairer to ensure that these safety standards are maintained.	
	4	-	4. Repairs must be made in accordance with the relevant safety standards.	
	5	-	5. It is essential that safety critical components are replaced by approved parts.	
	6	-	6. If mains voltage selector is provided, check setting for local voltage.	
	7	-	ILLUSTRATION(LXM-SA009-001_02.png)	

## STANDARD SCHEMATIC DIAGRAMS

### Description of Major ICs

Diagram Name	No.MB675<Rev.001>	No.MB675<Rev.002>	Description
Menu	-	U302: BI102024X BI102024X.xml	
Menu	-	U702: BI103952X BI103952X.xml	
Menu	-	U310: BI113231X BI113231X.xml	

Diagram Name	No.MB675<Rev.001>	No.MB675<Rev.002>	Description
Menu	-	<a href="#">U705: BI119711X</a> BI119711X.xml	
Menu	-	<a href="#">U703: BI117371X</a> NJM2233BM.xml	
Menu	-	<a href="#">U303: BI126541V</a> TDA7266SA.xml	

# PARTS LIST

## MODEL No. LIST

Model No.	No.MB675<Rev.002>
NX-PN7A	07
NX-PN7B	03
NX-PN7C	02
NX-PN7E	04
NX-PN7EN	05
NX-PN7EV	06
NX-PN7J	01
NX-PN7UJ	0A
NX-PN7US	08
NX-PN7UW	09

## General assembly [M1]

△	Symbol	or	Part No.		Part Name	Description	Qty	Models
			<Rev.001>	<Rev.002>				
	M1	6	-----	BI1005469102X1	FRONT CABINET	(Addition)	1	07,08,09,0A
	M1	13	-----	BI1005450302X1	DISPLAY WINDOW	(Addition)	1	07,08,09,0A
	M1	14	-----	BI1005480102X1	AD ORNAMENT	(Addition)	1	07,08,09,0A
	M1	35	-----	BI2035200101X1	BRACKET	(Addition)	1	03,04,05,06,07,08,09,0A

## Electrical parts list Main board [01]

△	Symbol	or	Part No.		Part Name	Description	Qty	Models
			<Rev.001>	<Rev.002>				
	01	U801	-----	BI100NS9543000	IC	(Addition)	1	03,04,05,06
	01	Q323	-----	DTC114TK	DIGI TRANSISTOR	(Addition)	1	03,04,05,06,07,08,09,0A
	01	D324	-----	MTZJ20B	Z DIODE	(Addition)	1	03,04,05,06,07,08,09,0A
	01	C437	-----	BICC475250KA02	C CAPACITOR	(Addition)	1	03,04,05,06,07,08,09,0A
	01	R303	BIRCW0100050X	-----	RESISTOR	(Deletion)	1	01,02
	01	R303	-----	BIRCW0100050X	RESISTOR	(Addition)	1	01,03,04,05,06,07,08,09,0A
	01	R330	-----	BIRC0000025A00	C RESISTOR	(Addition)	1	03,04,05,06,07,08,09,0A
	01	R357	-----	BIRC0000105A00	C RESISTOR	(Addition)	1	03,04,05,06
	01	R357	-----	BIRC1830105A00	C RESISTOR	(Addition)	1	07,08,09,0A
	01	CN302A	-----	BI12S30063X	SOCKET CONN	(Addition)	1	03,04,05,06
	01	CN307A	-----	BI12P30293X	CONNECTOR	(Addition)	1	03,04,05,06,07,08,09,0A
	01	RN801	-----	BIRN1020105A40	C RESISTOR	(Addition)	1	03,04,05,06

## DC jack board [05]

△	Symbol	or	Part No.		Part Name	Description	Qty	Models
			<Rev.001>	<Rev.002>				
	05	CN307B	-----	BI240V03396M01	CONNECTOR	(Addition)	1	03,04,05,06,07,08,09,0A
	05	JK204	-----	BI23A0541X	DC POWER JACK	(Addition)	1	03,04,05,06,07,08,09,0A

## Packing and accessories [M3]

△	Symbol	or	Part No.		Part Name	Description	Qty	Models
			<Rev.001>	<Rev.002>				
	M3	A1	-----	BI440002109000	INST BOOK	(Addition)	1	03
	M3	A1	-----	BI440002089000	INST BOOK	(Addition)	1	04
	M3	A1	-----	BI440002108000	INST BOOK	(Addition)	1	05
	M3	A1	-----	BI440002126000	INST BOOK	(Addition)	1	06
	M3	A1	-----	BI440002127000	INST BOOK	(Addition)	1	07
	M3	A1	-----	BI440002107000	INST BOOK	(Addition)	1	08
	M3	A1	-----	BI440002092000	INST BOOK	(Addition)	1	09
	M3	A1	-----	BI440002125000	INST BOOK	(Addition)	1	0A
	M3	A3	-----	BI400083291001	REGISTER CARD	(Addition)	1	03
	M3	A4	-----	-----	WARRANTY CARD	(Addition)	1	03,04,05,06
	M3	A4	-----	-----	WARRANTY CARD	(Addition)	1	07,08,09,0A
	M3	A5	-----	BIG60NXPN702BX	REMOCON UNIT	(Addition)	1	03,04,05,06
	M3	A8	-----	-----	BATTERY	(Addition)	1	01,02,03,04,05,06,07,08,09,0A
	M3	A9	-----	BI212011030001	AC ADAPTOR	(Addition)	1	03
	M3	A9	-----	BI212011023001	AC ADAPTOR	(Addition)	1	04,05,06,08,09,0A
	M3	A9	-----	BI212011029001	AC ADAPTOR	(Addition)	1	07
	M3	A10	-----	-----	WARRANTY CARD	(Addition)	1	07,08,09,0A
	M3	A11	-----	BI23A0095X	CONVERSION PLUG	(Addition)	1	08,09,0A

△	Symbol		or	Part No.		Part Name	Description	Qty	Models
				<Rev.001>	<Rev.002>				
	M3	P1		-----	BI410011378001	CARTON	(Addition)	1	03,04,05,06
	M3	P1		-----	BI410011411001	CARTON	(Addition)	1	07,08,09,0A
	M3	XXXXX		-----	-----	BATTERY	(Deletion)	1	01,02

# SPECIFICATION

## NX-PN7J,C

<b>Amplifier</b>				
Output Power	without iPod	7.5W per channel min. RMS driven into 8 Ω at 1 kHz with no more than 10% total harmonic distortion		
	with an iPod	7.0W per channel min. RMS driven into 8 Ω at 1 kHz with no more than 10% total harmonic distortion		
	with two iPod devices	6.3W per channel min. RMS driven into 8 Ω at 1 kHz with no more than 10% total harmonic distortion		
<b>Terminals</b>				
AUDIO IN	Input Sensitivity/ Impedance (1 kHz)	LEVEL 1: 500 mV/47 kΩ		
		LEVEL 2: 250 mV/47 kΩ		
		LEVEL 3: 125 mV/47 kΩ		
Dock A and B for iPod * Only for still picture.	Compatible iPod types	iPod nano 1GB/2GB/4GB	Audio yes Video no	
		iPod nano (2nd Generation) 2GB/4GB/8GB	Audio yes Video no	
		iPod nano (3rd Generation) 4GB/8GB	Audio yes Video yes	
		iPod mini 4GB	Audio yes Video no	
		iPod mini (2nd Generation) 4GB/ 6GB	Audio yes Video no	
		iPod (4th Generation) 20GB/40GB	Audio yes Video no	
		iPod photo (4th Generation) 20GB/30GB/40GB/60GB	Audio yes Video yes*	
		iPod video (5th Generation) 30GB/60GB/80GB	Audio yes Video yes	
		iPod classic 80GB/160GB	Audio yes Video yes	
		iPod touch 8GB/16GB/32GB	Audio yes Video yes	
		iPhone 4GB/8GB/16GB	Audio yes Video yes	
		Output power (each iPod)	DC 5 V=500 mA	
		VIDEO OUT (For iPod)	Composite	
PHONES	32 Ω - 1 kΩ			
	15 mW/ch output into 32 Ω			
<b>Tuner</b>				
FM tuning range	87.5 MHz - 108.0 MHz (100 kHz channel space)			
AM tuning range	530 kHz - 1710 kHz (10 kHz channel space)			
<b>Unit</b>				
Dimensions (W/H/D)	318 mm × 148 mm × 154 mm (12-9/16 inches × 5-7/8 inches × 6-1/8 inches)			
Mass	Approx. 2.6 kg (5.8 lbs)			
<b>Speaker Specifications</b>				
Type	Full range bass-reflex type			
Speakers	7 cm (2-13/16 inches) cone × 2			
Impedance	8 Ω			
<b>Power Specifications</b>				
Power Requirements	AC 120V~60 Hz, 0.4 A			
Power Consumption	35 W (power on mode)			
	4 W or less (in Standby mode)			
	2 W or less (in ECO mode)			
	19 W (in Standby mode with two iPod devices connected.)			

Design and specifications are subject to change without notice.

**NX-PN7BEENEV**

<b>Amplifier</b>			
Output Power		10 W (5 W + 5 W) at 8 $\Omega$ (10% THD) (IEC268-3)	
<b>Terminals</b>			
AUDIO IN	Input Sensitivity/ Impedance (1 kHz)	LEVEL 1: 500 mV/47 k $\Omega$	
		LEVEL 2: 250 mV/47 k $\Omega$	
		LEVEL 3: 125 mV/47 k $\Omega$	
Dock A and B for iPod * Only for still picture.	Compatible iPod types	iPod nano 1GB/2GB/4GB	Audio yes Video no
		iPod nano (2nd Generation) 2GB/4GB/8GB	Audio yes Video no
		iPod nano (3rd Generation) 4GB/8GB	Audio yes Video yes
		iPod mini 4GB	Audio yes Video no
		iPod mini (2nd Generation) 4GB/ 6GB	Audio yes Video no
		iPod (4th Generation) 20GB/40GB	Audio yes Video no
		iPod photo (4th Generation) 20GB/30GB/40GB/60GB	Audio yes Video yes*
		iPod video (5th Generation) 30GB/60GB/80GB	Audio yes Video yes
		iPod classic 80GB/160GB	Audio yes Video yes
		iPod touch 8GB/16GB/32GB	Audio yes Video yes
	iPhone 4GB/8GB/16GB	Audio yes Video yes	
Output power (each iPod)		DC 5 V 500 mA	
VIDEO OUT (For iPod)		Composite	
PHONES		32 $\Omega$ 1 k $\Omega$ 15 mW/ch output into 32 $\Omega$	
<b>Tuner</b>			
FM tuning range		87.50 MHz - 108.00 MHz	
<b>Unit</b>			
Dimensions (W/H/D)		318 mm $\times$ 148 mm $\times$ 154 mm	
Mass		Approx. 1.6 kg	
<b>Speaker Specifications</b>			
Type		Full range bass-reflex type	
Speakers		7 cm cone $\times$ 2	
Impedance		8 $\Omega$	
<b>Power Specifications</b>			
Power Source		DC 10.7 V 3 A (EXTERNAL DC IN)	
AC Adaptor (AA-R1001)	INPUT	AC 110 - 240 V 50 Hz/60 Hz 1 A	
	OUTPUT	DC 10.7 V 3 A 32.1 VA	
Power Consumption	35 W (power on mode)		
	4 W or less (in Standby mode)		
	1 W or less (in ECO mode)		
	19 W (in Standby mode with two iPod devices connected.)		

Design and specifications are subject to change without notice.

**NX-PN7AUSUJUW**

<b>Amplifier</b>				
Output Power	10 W (5 W + 5 W) at 8Ω(10% THD) (IEC268-3)			
<b>Terminals</b>				
AUDIO IN	Input Sensitivity/ Impedance (1 kHz)	LEVEL 1: 500 mV/47 kΩ LEVEL 2: 250 mV/47 kΩ LEVEL 3: 125 mV/47 kΩ		
Dock A and B for iPod * Only for still picture.	Compatible iPod types	iPod nano 1GB/2GB/4GB	Audio	yes
			Video	no
		iPod nano (2nd Generation) 2GB/4GB/8GB	Audio	yes
			Video	no
		iPod nano (3rd Generation) 4GB/8GB	Audio	yes
			Video	yes
		iPod mini 4GB	Audio	yes
			Video	no
		iPod mini (2nd Generation) 4GB/ 6GB	Audio	yes
			Video	no
		iPod (4th Generation) 20GB/40GB	Audio	yes
			Video	no
		iPod photo (4th Generation) 20GB/30GB/40GB/60GB	Audio	yes
	Video	yes*		
iPod video (5th Generation) 30GB/60GB/80GB	Audio	yes		
	Video	yes		
	iPod classic 80GB/160GB	Audio	yes	
		Video	yes	
	iPod touch 8GB/16GB/32GB	Audio	yes	
		Video	yes	
	iPhone 4GB/8GB/16GB	Audio	yes	
		Video	yes	
Output power (each iPod)	DC 5 V 500 mA			
VIDEO OUT (For iPod)	Composite			
PHONES	32Ω 1 kΩ			
	15 mW/ch output into 32 Ω			
<b>Tuner</b>				
FM tuning range	87.50 MHz-108.00 MHz			
<b>Unit</b>				
Dimensions (W/H/D)	318 mm × 148 mm × 154 mm			
Mass	Approx. 1.6 kg			
<b>Speaker Specifications</b>				
Type	Full range bass-reflex type			
Speakers	7 cm cone × 2			
Impedance	8 Ω			
<b>Power Specifications</b>				
Power Source	DC 10.7 V 3 A (EXTERNAL DC IN)			
AC Adaptor (AA-R1001)	INPUT	AC 110 - 240 V , 50 Hz/60 Hz 1 A		
	OUTPUT	DC 10.7 V 3 A		
Power Consumption:	35 W (power on mode)			
	4 W or less (in Standby mode)			
	1 W or less (in ECO mode)			
	19 W (in Standby mode with two iPod devices connected.)			

Design and specifications are subject to change without notice.

# SECTION 1 PRECAUTION

## 1.1 Safety Precautions

- (1) This design of this product contains special hardware and many circuits and components specially for safety purposes. For continued protection, no changes should be made to the original design unless authorized in writing by the manufacturer. Replacement parts must be identical to those used in the original circuits. Services should be performed by qualified personnel only.
- (2) Alterations of the design or circuitry of the product should not be made. Any design alterations of the product should not be made. Any design alterations or additions will void the manufacturer's warranty and will further relieve the manufacturer of responsibility for personal injury or property damage resulting therefrom.
- (3) Many electrical and mechanical parts in the products have special safety-related characteristics. These characteristics are often not evident from visual inspection nor can the protection afforded by them necessarily be obtained by using replacement components rated for higher voltage, wattage, etc. Replacement parts which have these special safety characteristics are identified in the Parts List of Service Manual. Electrical components having such features are identified by shading on the schematics and by ( $\Delta$ ) on the Parts List in the Service Manual. The use of a substitute replacement which does not have the same safety characteristics as the recommended replacement parts shown in the Parts List of Service Manual may create shock, fire, or other hazards.
- (4) The leads in the products are routed and dressed with ties, clamps, tubings, barriers and the like to be separated from live parts, high temperature parts, moving parts and/or sharp edges for the prevention of electric shock and fire hazard. When service is required, the original lead routing and dress should be observed, and it should be confirmed that they have been returned to normal, after reassembling.
- (5) Leakage shock hazard testing

After reassembling the product, always perform an isolation check on the exposed metal parts of the product (antenna terminals, knobs, metal cabinet, screw heads, headphone jack, control shafts, etc.) to be sure the product is safe to operate without danger of electrical shock. Do not use a line isolation transformer during this check.

- Plug the AC line cord directly into the AC outlet. Using a "Leakage Current Tester", measure the leakage current from each exposed metal part of the cabinet, particularly any exposed metal part having a return path to the chassis, to a known good earth ground. Any leakage current must not exceed 0.5mA AC (r.m.s.).
- Alternate check method  
Plug the AC line cord directly into the AC outlet. Use an AC voltmeter having, 1,000 $\Omega$  per volt or more sensitivity in the following manner. Connect a 1,500 $\Omega$  10W resistor paralleled by a 0.15 $\mu$ F AC-type capacitor between an exposed metal part and a known good earth ground. Measure the AC voltage across the resistor with the AC

voltmeter.

Move the resistor connection to each exposed metal part, particularly any exposed metal part having a return path to the chassis, and measure the AC voltage across the resistor. Now, reverse the plug in the AC outlet and repeat each measurement. Voltage measured any must not exceed 0.75 V AC (r.m.s.). This corresponds to 0.5 mA AC (r.m.s.).

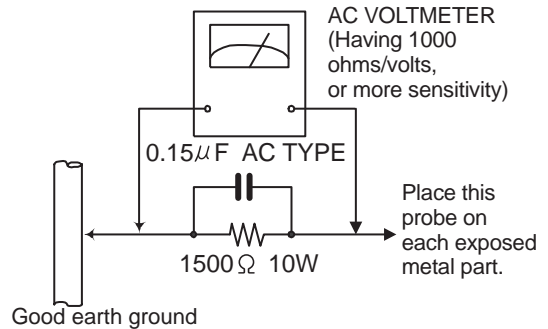

## 1.2 Warning

- (1) This equipment has been designed and manufactured to meet international safety standards.
- (2) It is the legal responsibility of the repairer to ensure that these safety standards are maintained.
- (3) Repairs must be made in accordance with the relevant safety standards.
- (4) It is essential that safety critical components are replaced by approved parts.
- (5) If mains voltage selector is provided, check setting for local voltage.

## 1.3 Caution

**Burrs formed during molding may be left over on some parts of the chassis.**

**Therefore, pay attention to such burrs in the case of pre-forming repair of this system.**

## 1.4 Critical parts for safety

In regard with component parts appearing on the silk-screen printed side (parts side) of the PWB diagrams, the parts that are printed over with black such as the resistor (  $\blacksquare$  ), diode (  $\blacksquare$  ) and ICP (  $\bullet$  ) or identified by the " $\Delta$ " mark nearby are critical for safety. When replacing them, be sure to use the parts of the same type and rating as specified by the manufacturer. (This regulation does not Except the J and C version)



## 1.5 Safety Precautions (U.K only)

- (1) This design of this product contains special hardware and many circuits and components specially for safety purposes. For continued protection, no changes should be made to the original design unless authorized in writing by the manufacturer. Replacement parts must be identical to those used in the original circuits.
- (2) Any unauthorised design alterations or additions will void the manufacturer's guarantee; furthermore the manufacturer cannot accept responsibility for personal injury or property damage resulting therefrom.
- (3) Essential safety critical components are identified by (  ) on the Parts List and by shading on the schematics, and must never be replaced by parts other than those listed in the manual. Please note however that many electrical and mechanical parts in the product have special safety related characteristics. These characteristics are often not evident from visual inspection. Parts other than specified by the manufacturer may not have the same safety characteristics as the recommended replacement parts shown in the Parts List of the Service Manual and may create shock, fire, or other hazards.
- (4) The leads in the products are routed and dressed with ties, clamps, tubings, barriers and the like to be separated from live parts, high temperature parts, moving parts and/or sharp edges for the prevention of electric shock and fire hazard. When service is required, the original lead routing and dress should be observed, and it should be confirmed that they have been returned to normal, after re-assembling.

### 1.5.1 Warning

- (1) Service should be performed by qualified personnel only.
- (2) This equipment has been designed and manufactured to meet international safety standards.
- (3) It is the legal responsibility of the repairer to ensure that these safety standards are maintained.
- (4) Repairs must be made in accordance with the relevant safety standards.
- (5) It is essential that safety critical components are replaced by approved parts.
- (6) If mains voltage selector is provided, check setting for local voltage.



**CAUTION** Burrs formed during molding may be left over on some parts of the chassis. Therefore, pay attention to such burrs in the case of performing repair of this system.

## SECTION 2 SPECIFIC SERVICE INSTRUCTIONS

This service manual does not describe SPECIFIC SERVICE INSTRUCTIONS.

## SECTION 3 DISASSEMBLY

### 3.1 Main body (Used figure are NX-PN7J)

#### 3.1.1 Removing the Rear cabinet (See Fig.1, 2)

- (1) Remove the thirteen screws **A** attaching the Rear cabinet. (See Fig.1)
- (2) Disconnect the card wire from LCD board connected to connector **CN308** of the Main board. (See Fig.2)
- (3) Disconnect the connector wire from LED board connected to connector **CN713A** of the Main board. (See Fig.2)
- (4) Disconnect the connector wire from iPod board connected to connector **CN710A** of the Main board. (See Fig.2)
- (5) Disconnect the connector wire from iPod board connected to connector **CN711A** of the Main board. (See Fig.2)
- (6) Disconnect the connector wire from LED board connected to connector **CN712A** of the Main board. (See Fig.2)
- (7) Disconnect the connector wire from Speakers connected to connector **CN304** of the Main board. (See Fig.2)

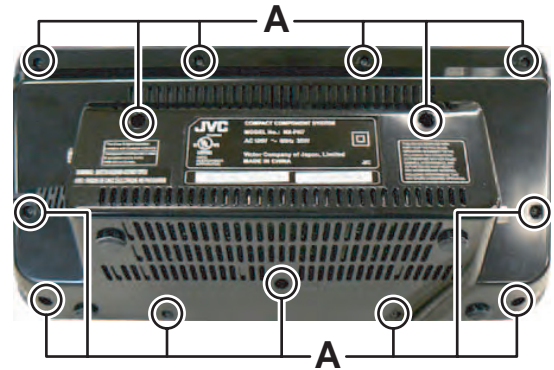

Fig.1

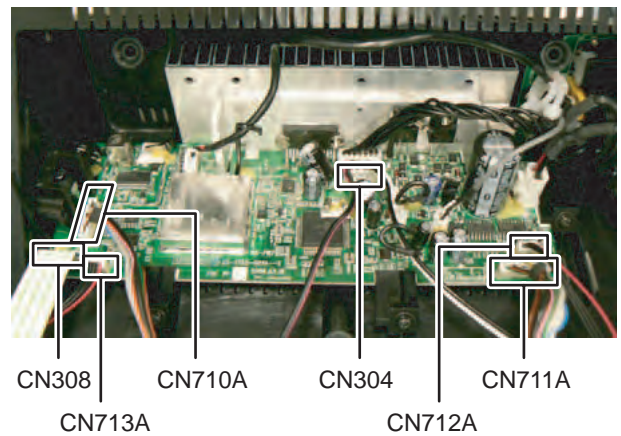
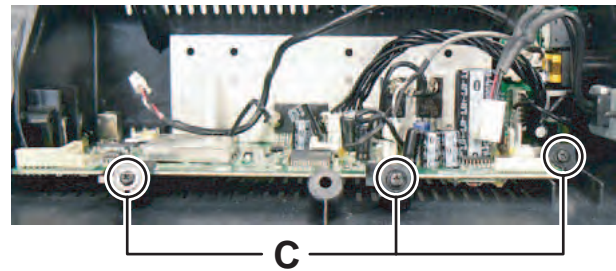
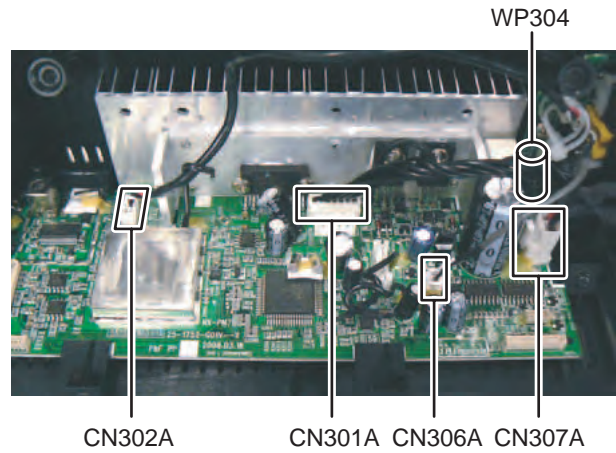

Fig.2

### 3.1.2 Removing the Main board (See Fig.3 to 5)

- (1) Disconnect the connector wires from Jack board connected to connector [CN301A](#), [CN302A](#) and [CN306A](#) of the Main board. (See Fig.3)
- (2) Disconnect the Earth wire connected to post pin [WP304](#) of the Main board. (See Fig.3)
- (3) Disconnect the connector wire from AC adapter connected to connector [CN307A](#) of the Main board. (See Fig.3)
- (4) Remove the two screws **B** attaching the Antenna terminal. (See Fig.4)
- (5) Remove the three screws **C** attaching the Main board. (See Fig.5)



### 3.1.3 Removing the AC adapter (See Fig.6)

- (1) Remove the two screws **D** attaching the AC adapter.

### 3.1.4 Removing the Jack board (See Fig.6)

- (1) Remove the one screw **E** attaching the Jack board.

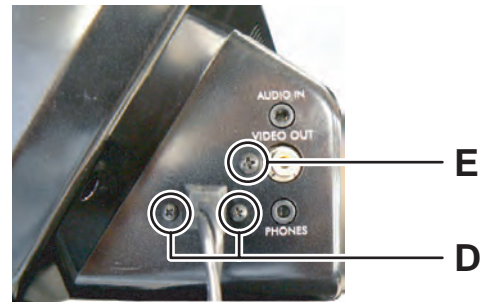

### 3.1.5 Removing the LCD board (See Fig.7)

- (1) Remove the seven screws **F** attaching the LCD board.

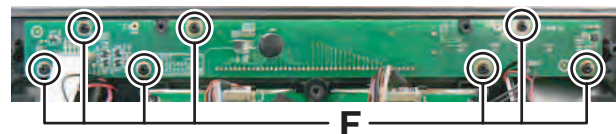

### 3.1.6 Removing the LED boards (See Fig.8)

Remove the two screws **G** attaching the LED boards.

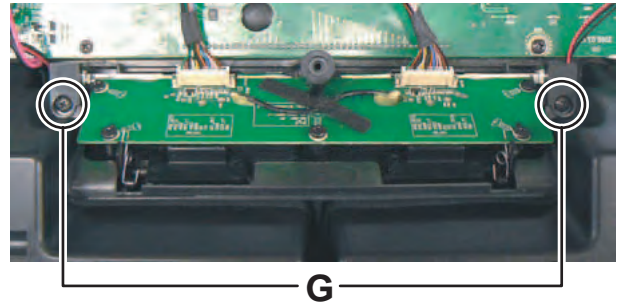

Fig.8

### 3.1.7 Removing the iPod board (See Fig.9 to 12)

- (1) Remove the twelve screws **H** attaching the Speaker covers. (See Fig.9)
- (2) Remove the four screws **J** attaching the Duct. (See Fig.10)
- (3) Remove the four screws **K** attaching the Holder. (See Fig.11)
- (4) Remove the five screws **L** attaching the iPod board. (See Fig.12)
- (5) Turn over the iPod board and then remove the cover spring.

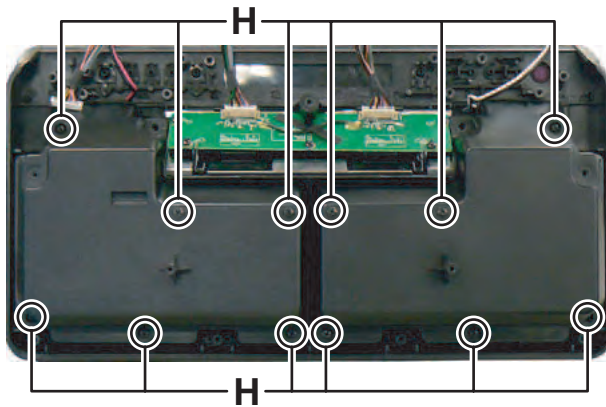

Fig.9

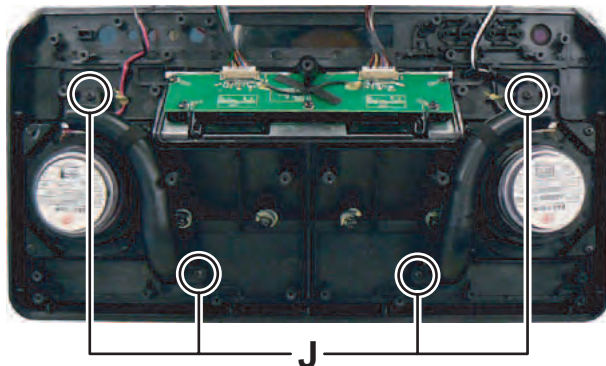

Fig.10

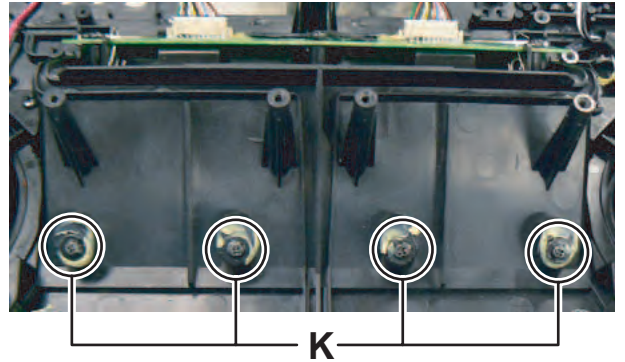

Fig.11

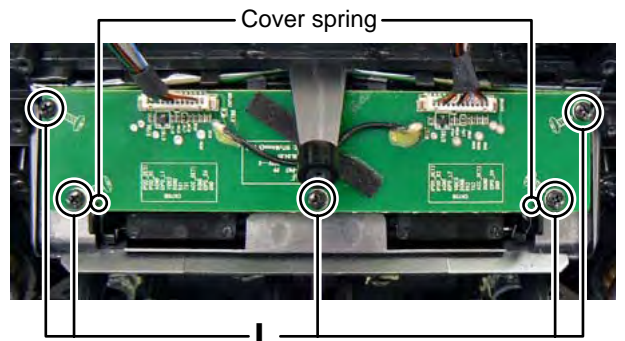

Fig.12

## **SECTION 4 ADJUSTMENT**

This service manual does not describe ADJUSTMENT.

## **SECTION 5 TROUBLESHOOTING**

This service manual does not describe TROUBLESHOOTING.





**JVC**

Victor Company of Japan, Limited  
Audio/Video Systems Division 10-1, 1chome, Ohwatari-machi, Maebashi-city, 371-8543, Japan

---

(No.MB675<Rev.002>)

Printed in Japan  
VPT